

# FQD1N60C / FQU1N60C

## 600V N-Channel MOSFET

### General Description

These N-Channel enhancement mode power field effect transistors are produced using Fairchild's proprietary, planar stripe, DMOS technology.

This advanced technology has been especially tailored to minimize on-state resistance, provide superior switching performance, and withstand high energy pulse in the avalanche and commutation mode. These devices are well suited for high efficiency switched mode power supplies, active power factor correction, electronic lamp ballasts based on half bridge topology.

### Features

- 1A, 600V,  $R_{DS(on)} = 11.5\Omega @ V_{GS} = 10V$
- Low gate charge ( typical 4.8nC)
- Low Crss ( typical 3.5 pF)
- Fast switching
- 100% avalanche tested
- Improved dv/dt capability

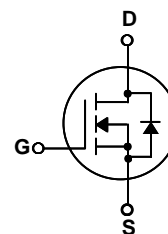
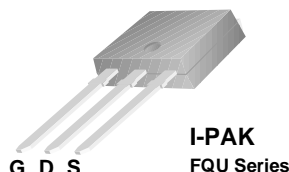
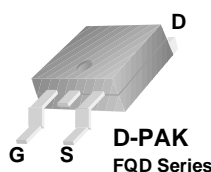

### Absolute Maximum Ratings T<sub>C</sub> = 25°C unless otherwise noted

Symbol	Parameter	FQD1N60C / FQU1N60C	Units
V <sub>DSS</sub>	Drain-Source Voltage	600	V
I <sub>D</sub>	Drain Current - Continuous (T <sub>C</sub> = 25°C) - Continuous (T <sub>C</sub> = 100°C)	1	A
		0.6	A
I <sub>DM</sub>	Drain Current - Pulsed (Note 1)	4	A
V <sub>GSS</sub>	Gate-Source Voltage	± 30	V
E <sub>AS</sub>	Single Pulsed Avalanche Energy (Note 2)	33	mJ
I <sub>AR</sub>	Avalanche Current (Note 1)	1	A
E <sub>AR</sub>	Repetitive Avalanche Energy (Note 1)	2.8	mJ
dv/dt	Peak Diode Recovery dv/dt (Note 3)	4.5	V/ns
P <sub>D</sub>	Power Dissipation (T <sub>A</sub> = 25°C)*	2.5	W
	Power Dissipation (T <sub>C</sub> = 25°C)	28	W
	- Derate above 25°C	0.22	W/°C
T <sub>J</sub> , T <sub>STG</sub>	Operating and Storage Temperature Range	-55 to +150	°C
T <sub>L</sub>	Maximum lead temperature for soldering purposes, 1/8" from case for 5 seconds	300	°C

### Thermal Characteristics

Symbol	Parameter	Typ	Max	Units
R <sub>θJC</sub>	Thermal Resistance, Junction-to-Case	--	4.53	°C/W
R <sub>θJA</sub>	Thermal Resistance, Junction-to-Ambient*	--	50	°C/W
R <sub>θJA</sub>	Thermal Resistance, Junction-to-Ambient	--	110	°C/W

\* When mounted on the minimum pad size recommended (PCB Mount)

## Electrical Characteristics

$T_C = 25^\circ\text{C}$  unless otherwise noted

Symbol	Parameter	Test Conditions	Min	Typ	Max	Units
<b>Off Characteristics</b>						
$BV_{DSS}$	Drain-Source Breakdown Voltage	$V_{GS} = 0\text{ V}, I_D = 250\ \mu\text{A}$	600	--	--	V
$\Delta BV_{DSS} / \Delta T_J$	Breakdown Voltage Temperature Coefficient	$I_D = 250\ \mu\text{A}$ , Referenced to $25^\circ\text{C}$	--	0.6	--	V/ $^\circ\text{C}$
$I_{DSS}$	Zero Gate Voltage Drain Current	$V_{DS} = 600\text{ V}, V_{GS} = 0\text{ V}$	--	--	1	$\mu\text{A}$
		$V_{DS} = 480\text{ V}, T_C = 125^\circ\text{C}$	--	--	10	$\mu\text{A}$
$I_{GSSF}$	Gate-Body Leakage Current, Forward	$V_{GS} = 30\text{ V}, V_{DS} = 0\text{ V}$	--	--	100	nA
$I_{GSSR}$	Gate-Body Leakage Current, Reverse	$V_{GS} = -30\text{ V}, V_{DS} = 0\text{ V}$	--	--	-100	nA

### On Characteristics

$V_{GS(th)}$	Gate Threshold Voltage	$V_{DS} = V_{GS}, I_D = 250\ \mu\text{A}$	2.0	--	4.0	V
$R_{DS(on)}$	Static Drain-Source On-Resistance	$V_{GS} = 10\text{ V}, I_D = 0.5\text{ A}$	--	9.3	11.5	$\Omega$
$g_{FS}$	Forward Transconductance	$V_{DS} = 40\text{ V}, I_D = 0.5\text{ A}$ (Note 4)	--	0.75	--	S

### Dynamic Characteristics

$C_{iss}$	Input Capacitance	$V_{DS} = 25\text{ V}, V_{GS} = 0\text{ V},$ $f = 1.0\text{ MHz}$	--	130	170	pF
$C_{oss}$	Output Capacitance		--	19	25	pF
$C_{riss}$	Reverse Transfer Capacitance		--	3.5	4.5	pF

### Switching Characteristics

$t_{d(on)}$	Turn-On Delay Time	$V_{DD} = 300\text{ V}, I_D = 1.1\text{ A},$ $R_G = 25\ \Omega$	--	7	24	ns
$t_r$	Turn-On Rise Time		--	21	52	ns
$t_{d(off)}$	Turn-Off Delay Time		--	13	36	ns
$t_f$	Turn-Off Fall Time		(Note 4, 5)	--	27	64
$Q_g$	Total Gate Charge	$V_{DS} = 480\text{ V}, I_D = 1.1\text{ A},$ $V_{GS} = 10\text{ V}$	--	4.8	6.2	nC
$Q_{gs}$	Gate-Source Charge		--	0.7	--	nC
$Q_{gd}$	Gate-Drain Charge		(Note 4, 5)	--	2.7	--

### Drain-Source Diode Characteristics and Maximum Ratings

$I_S$	Maximum Continuous Drain-Source Diode Forward Current	--	--	1	A	
$I_{SM}$	Maximum Pulsed Drain-Source Diode Forward Current	--	--	4	A	
$V_{SD}$	Drain-Source Diode Forward Voltage	$V_{GS} = 0\text{ V}, I_S = 0.5\text{ A}$	--	--	1.4	V
$t_{rr}$	Reverse Recovery Time	$V_{GS} = 0\text{ V}, I_S = 1.1\text{ A},$	--	190	--	ns
$Q_{rr}$	Reverse Recovery Charge	$di_F / dt = 100\text{ A}/\mu\text{s}$ (Note 4)	--	0.53	--	$\mu\text{C}$

#### Notes:

1. Repetitive Rating : Pulse width limited by maximum junction temperature
2.  $L = 59\text{ mH}, I_{AS} = 1.1\text{ A}, V_{DD} = 50\text{ V}, R_G = 25\ \Omega$ , Starting  $T_J = 25^\circ\text{C}$
3.  $I_{SD} \leq 1.1\text{ A}, di/dt \leq 200\text{ A}/\mu\text{s}, V_{DD} \leq BV_{DSS}$ , Starting  $T_J = 25^\circ\text{C}$
4. Pulse Test : Pulse width  $\leq 300\ \mu\text{s}$ , Duty cycle  $\leq 2\%$
5. Essentially independent of operating temperature

## Typical Characteristics

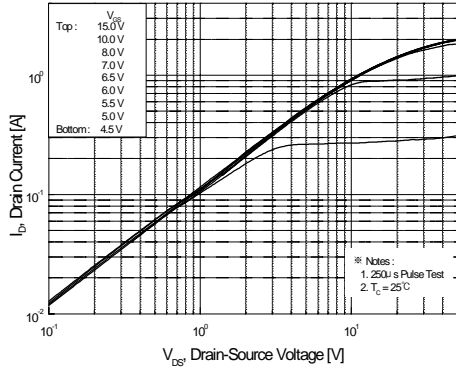

Figure 1. On-Region Characteristics

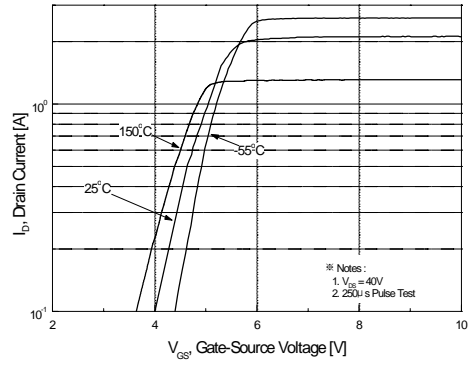

Figure 2. Transfer Characteristics

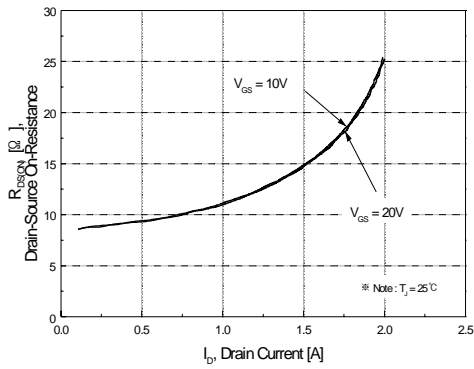

Figure 3. On-Resistance Variation vs Drain Current and Gate Voltage

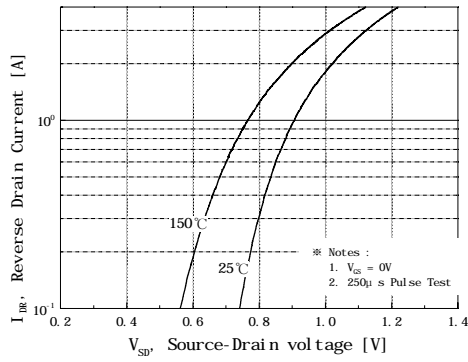

Figure 4. Body Diode Forward Voltage Variation with Source Current and Temperature

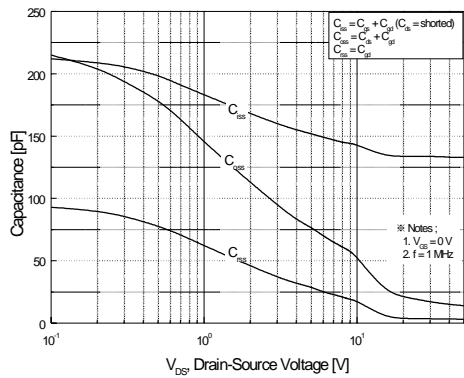

Figure 5. Capacitance Characteristics

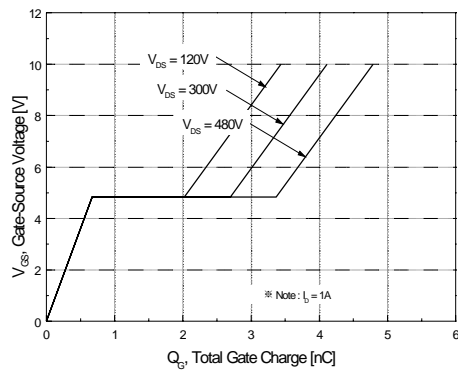
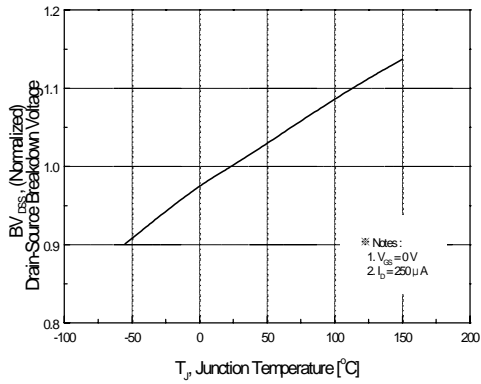
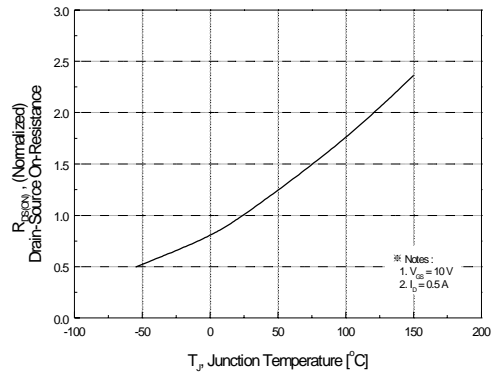

Figure 6. Gate Charge Characteristics

**Typical Characteristics** (Continued)



**Figure 7. Breakdown Voltage Variation vs Temperature**



**Figure 8. On-Resistance Variation vs Temperature**

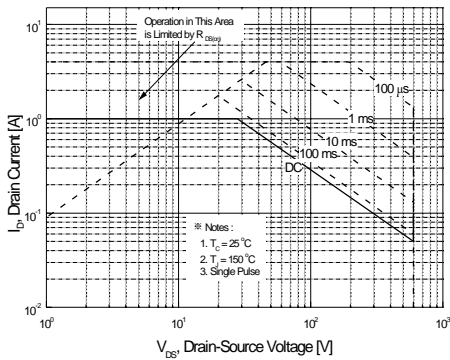

**Figure 9. Maximum Safe Operating Area**

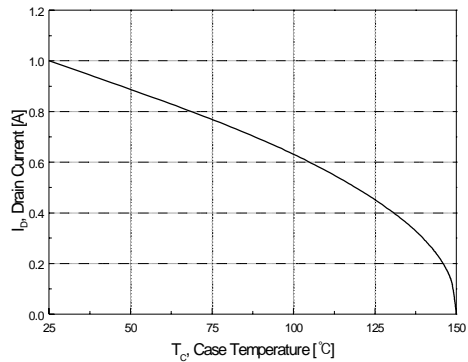

**Figure 10. Maximum Drain Current vs Case Temperature**

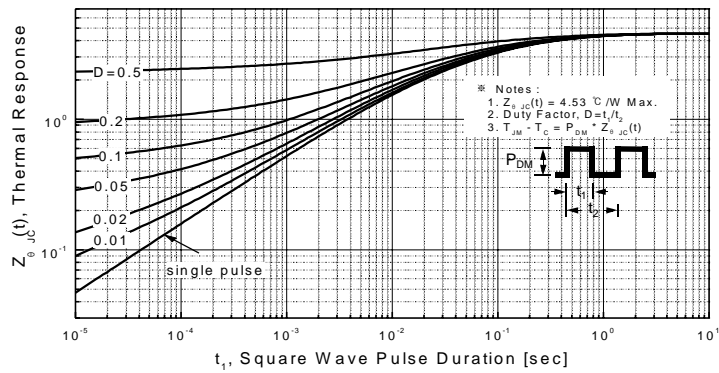

**Figure 11. Transient Thermal Response Curve**

**Gate Charge Test Circuit & Waveform**



**Resistive Switching Test Circuit & Waveforms**



**Unclamped Inductive Switching Test Circuit & Waveforms**

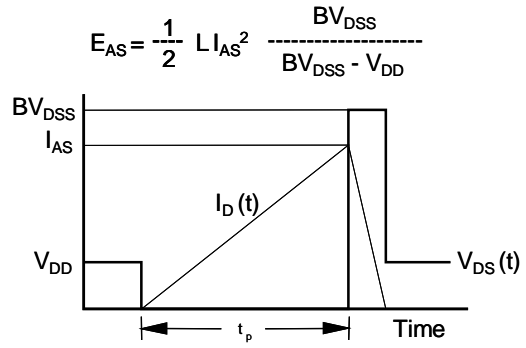

### Peak Diode Recovery dv/dt Test Circuit & Waveforms

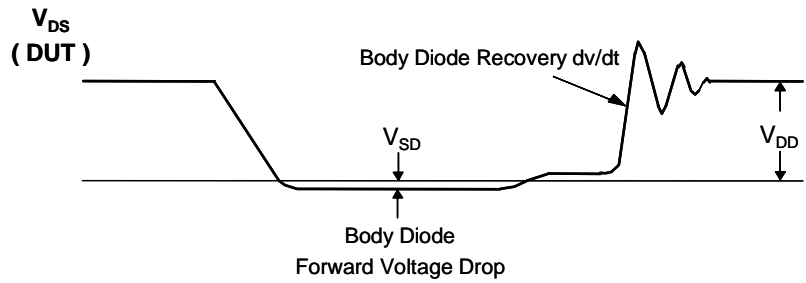

# Package Dimensions

## D-PAK

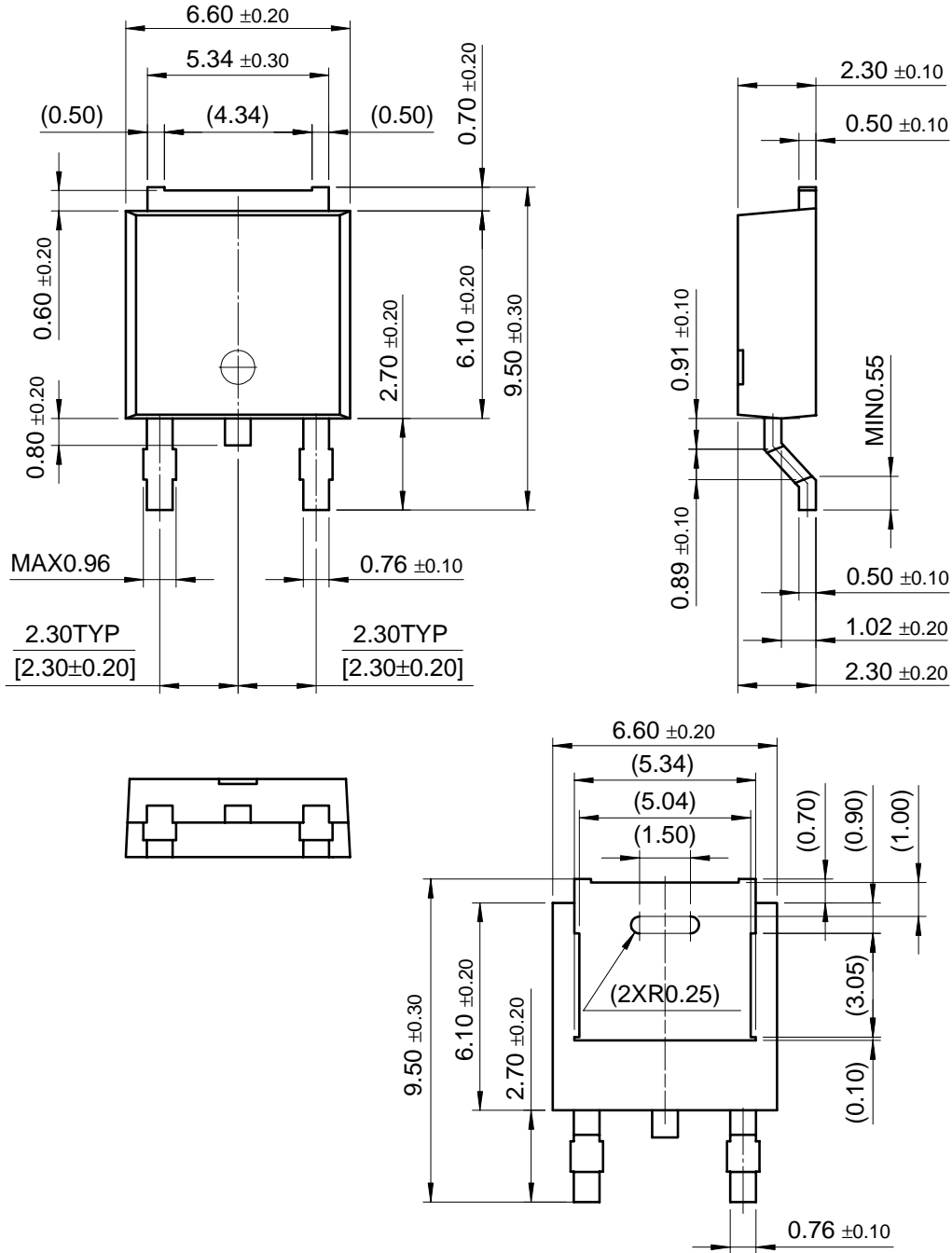

FQD1N60C / FQU1N60C

Dimensions in Millimeters

Package Dimensions (Continued)

I-PAK

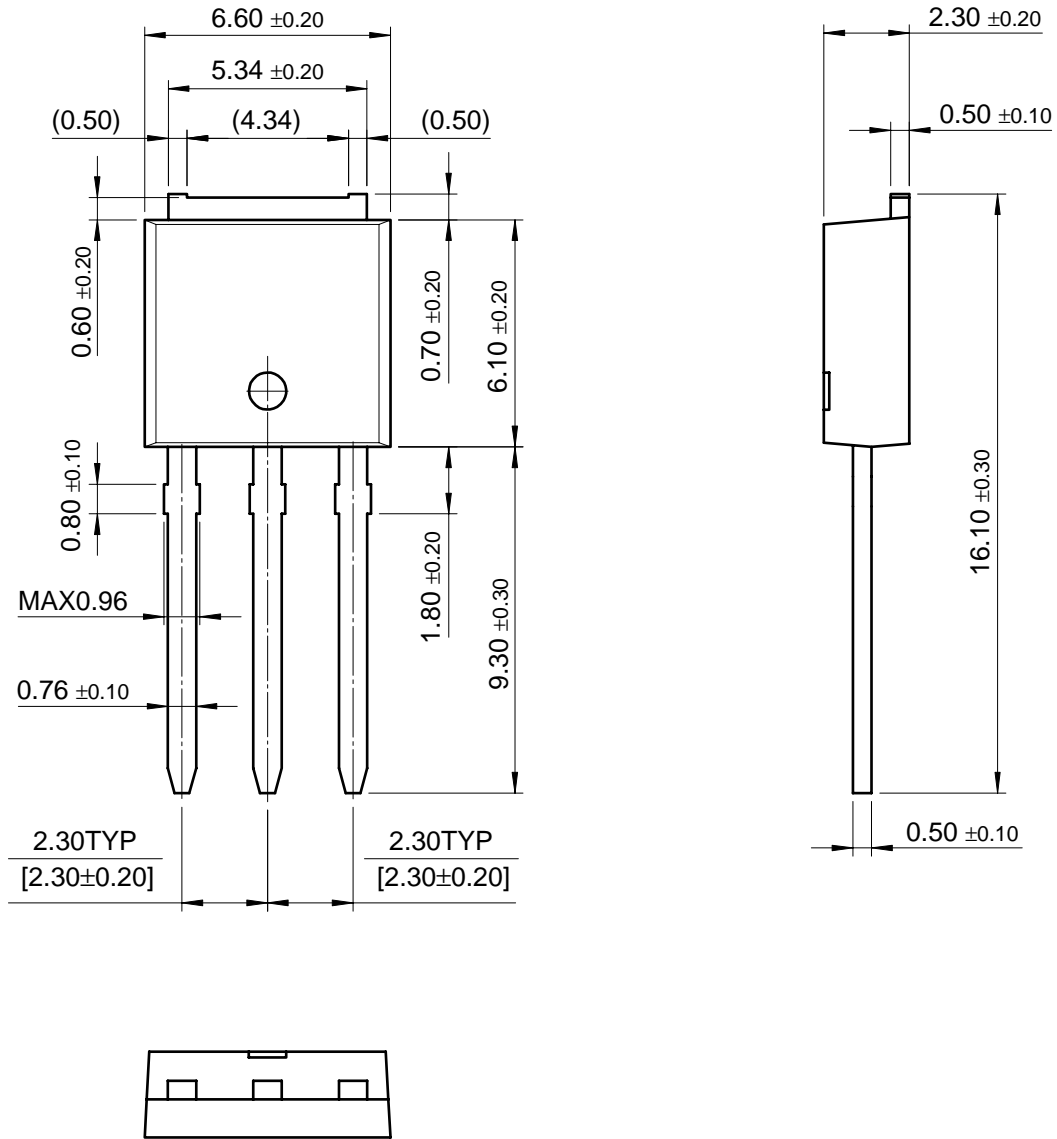

FQD1N60C / FQU1N60C

Dimensions in Millimeters



## TRADEMARKS

The following are registered and unregistered trademarks Fairchild Semiconductor owns or is authorized to use and is not intended to be an exhaustive list of all such trademarks.

ACE <sup>x</sup> <sup>TM</sup>	FACT Quiet Series <sup>TM</sup>	LittleFET <sup>TM</sup>	Power247 <sup>TM</sup>	SuperSOT <sup>TM</sup> -6
ActiveArray <sup>TM</sup>	FAST <sup>®</sup>	MICROCOUPLER <sup>TM</sup>	PowerTrench <sup>®</sup>	SuperSOT <sup>TM</sup> -8
Bottomless <sup>TM</sup>	FAST <sup>r</sup> <sup>TM</sup>	MicroFET <sup>TM</sup>	QFET <sup>®</sup>	SyncFET <sup>TM</sup>
CoolFET <sup>TM</sup>	FRFET <sup>TM</sup>	MicroPak <sup>TM</sup>	QS <sup>TM</sup>	TinyLogic <sup>®</sup>
CROSSVOLT <sup>TM</sup>	GlobalOptoisolator <sup>TM</sup>	MICROWIRE <sup>TM</sup>	QT Optoelectronics <sup>TM</sup>	TINYOPTO <sup>TM</sup>
DOMET <sup>TM</sup>	GTO <sup>TM</sup>	MSX <sup>TM</sup>	Quiet Series <sup>TM</sup>	TruTranslation <sup>TM</sup>
EcoSPARK <sup>TM</sup>	HiSeC <sup>TM</sup>	MSXPro <sup>TM</sup>	RapidConfigure <sup>TM</sup>	UHC <sup>TM</sup>
E <sup>2</sup> CMOS <sup>TM</sup>	I <sup>2</sup> C <sup>TM</sup>	OCX <sup>TM</sup>	RapidConnect <sup>TM</sup>	UltraFET <sup>®</sup>
EnSigna <sup>TM</sup>	ImpliedDisconnect <sup>TM</sup>	OCXPro <sup>TM</sup>	SILENT SWITCHER <sup>®</sup>	VCX <sup>TM</sup>
FACT <sup>TM</sup>	ISOPLANAR <sup>TM</sup>	OPTOLOGIC <sup>®</sup>	SMART START <sup>TM</sup>	
Across the board. Around the world. <sup>TM</sup>		OPTOPLANAR <sup>TM</sup>	SPM <sup>TM</sup>	
The Power Franchise <sup>TM</sup>		PACMAN <sup>TM</sup>	Stealth <sup>TM</sup>	
Programmable Active Droop <sup>TM</sup>		POP <sup>TM</sup>	SuperSOT <sup>TM</sup> -3	

## DISCLAIMER

FAIRCHILD SEMICONDUCTOR RESERVES THE RIGHT TO MAKE CHANGES WITHOUT FURTHER NOTICE TO ANY PRODUCTS HEREIN TO IMPROVE RELIABILITY, FUNCTION OR DESIGN. FAIRCHILD DOES NOT ASSUME ANY LIABILITY ARISING OUT OF THE APPLICATION OR USE OF ANY PRODUCT OR CIRCUIT DESCRIBED HEREIN; NEITHER DOES IT CONVEY ANY LICENSE UNDER ITS PATENT RIGHTS, NOR THE RIGHTS OF OTHERS.

## LIFE SUPPORT POLICY

FAIRCHILD'S PRODUCTS ARE NOT AUTHORIZED FOR USE AS CRITICAL COMPONENTS IN LIFE SUPPORT DEVICES OR SYSTEMS WITHOUT THE EXPRESS WRITTEN APPROVAL OF FAIRCHILD SEMICONDUCTOR CORPORATION.

As used herein:

1. Life support devices or systems are devices or systems which, (a) are intended for surgical implant into the body, or (b) support or sustain life, or (c) whose failure to perform when properly used in accordance with instructions for use provided in the labeling, can be reasonably expected to result in significant injury to the user.
2. A critical component is any component of a life support device or system whose failure to perform can be reasonably expected to cause the failure of the life support device or system, or to affect its safety or effectiveness.

## PRODUCT STATUS DEFINITIONS

### Definition of Terms

Datasheet Identification	Product Status	Definition
Advance Information	Formative or In Design	This datasheet contains the design specifications for product development. Specifications may change in any manner without notice.
Preliminary	First Production	This datasheet contains preliminary data, and supplementary data will be published at a later date. Fairchild Semiconductor reserves the right to make changes at any time without notice in order to improve design.
No Identification Needed	Full Production	This datasheet contains final specifications. Fairchild Semiconductor reserves the right to make changes at any time without notice in order to improve design.
Obsolete	Not In Production	This datasheet contains specifications on a product that has been discontinued by Fairchild semiconductor. The datasheet is printed for reference information only.